



50

**Cross-Connection Questions,
Answers & Illustrations**

Relating to
Backflow Prevention Products
and Protection of
Safe Drinking Water Supply

1 What is backsiphonage?

Backsiphonage is the reversal of normal flow in a system caused by a negative pressure (vacuum or partial vacuum) in the supply piping.

2 What factors can cause backsiphonage?

Backsiphonage can be created when there is stoppage of the water supply due to nearby firefighting, repairs or breaks in city main, etc. The effect is similar to the sipping of a soda by inhaling through a straw, which induces a flow in the opposite direction.



3 What is backpressure backflow?

Backpressure backflow is the reversal of normal flow in a system due to an increase in the downstream pressure above that of the supply pressure.

4 What factors can cause a backpressure backflow condition?

Backpressure backflow is created whenever the downstream pressure exceeds the supply pressure which is possible in installations such as heating systems, elevated tanks, and pressure-producing systems. An example would be a hot water space-heating boiler operating under 15-20 lbs. pressure coincidental with a reduction of the city water supply below such pressure (or higher in most commercial boilers). As water tends to flow in the direction of least resistance, a backpressure backflow condition would be created and the contaminated boiler water would flow into the potable water supply.

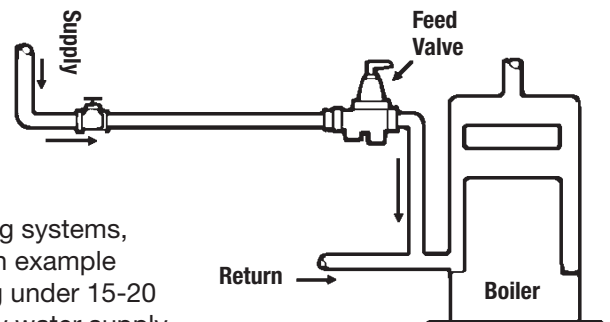

5 What is a cross-connection?

A cross-connection is a direct arrangement of a piping line which allows the potable water supply to be connected to a line which contains a contaminant. An example is the common garden hose attached to a sill cock with the end of the hose lying in a cesspool. Other examples are a garden hose attached to a service sink with the end of the hose submerged in a tub full of detergent, supply lines connected to bottom-fed tanks, supply lines connected to boilers.

6 What is the most common form of a cross-connection?

Ironically, the ordinary garden hose is the most common offender as it can be easily connected to the potable water supply and used for a variety of potentially dangerous applications.

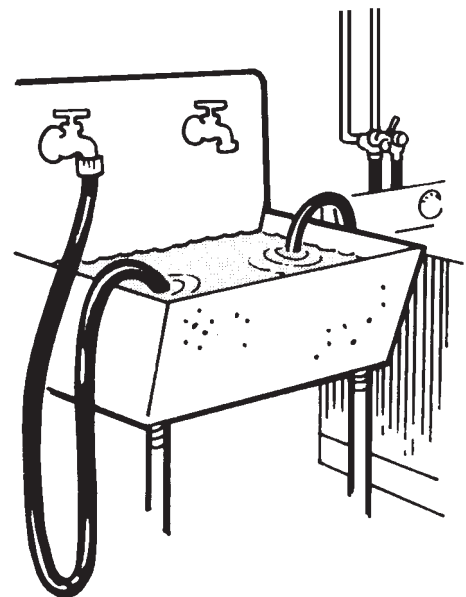

7 What is potentially dangerous about an unprotected sill cock?

The purpose of a sill cock is to permit easy attachment of a hose for outside watering purposes. However, a garden hose can be extremely hazardous because they are left submerged in swimming pools, lay in elevated locations (above the sill cock) watering shrubs, chemical sprayers are attached to hoses for weed-killing, etc.; and hoses are often left laying on the ground which may be contaminated with fertilizer, cesspools, and garden chemicals.

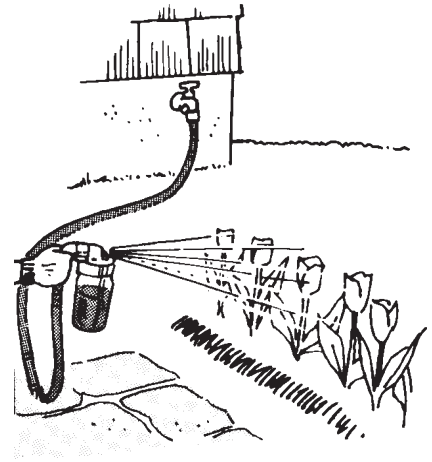

8 What protection is required for sill cocks?

A Hose Bibb Vacuum Breaker should be installed on every sill cock to isolate garden hose applications thus protecting the potable water supply from contamination.

9 Should a Hose Bibb Vacuum Breaker be used on frost-free hydrants?

Definitely, providing the device is equipped with means to permit the line to drain after the hydrant is shut off. A “removable” type Hose Bibb Vacuum Breaker could allow the hydrant to be drained, but the possibility exists that users might fail to remove it for draining purposes, thus defeating the benefit of the frost-proof hydrant feature. If the device is of the “Non-Removable” type, be sure it is equipped with means to drain the line to prevent winter freezing.



Hose Bibb Vacuum Breaker
Watts 8

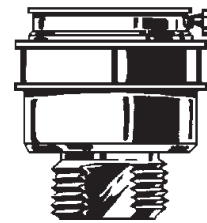

Hose Bibb Vacuum Breaker
for Frost-Proof Hydrants
Watts NF8

10 Can an Atmospheric, Antisiphon Vacuum Breaker be installed on a hose bibb?

Theoretically yes, but practically no. An Antisiphon Vacuum Breaker must be elevated above the sill cock to operate properly. This would require elevated piping up to the vacuum breaker and down to the sill cock and is normally not a feasible installation. On the other hand, a Hose Bibb Vacuum Breaker can be attached directly to the sill cock without plumbing changes and at minor cost.

11 What is an Atmospheric Vacuum Breaker?

The most commonly used Atmospheric Antisiphon Vacuum Breakers incorporate an atmospheric vent in combination with a check valve. Its operation depends on a supply of potable water to seal off the atmospheric vent, admitting the water to downstream equipment. If a negative pressure develops in the supply line, the loss of pressure permits the check valve to drop sealing the orifice while at the same time the vent opens admitting air to the system to break the vacuum.

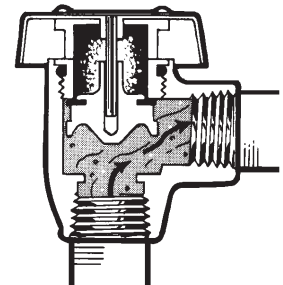

Atmospheric Vacuum Breaker
Watts 288A

12 Will an Antisiphon Vacuum Breaker protect against a backpressure backflow condition?

Absolutely not! If there is an increase in the downstream pressure over that of the supply pressure, the check valve would tend to “modulate” thus permitting the backflow of contaminated water to pass through the orifice into the potable water supply line.

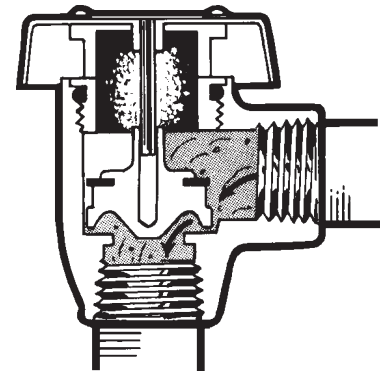

13 Can an Atmospheric Vacuum Breaker be used on lawn sprinkler systems?

Yes, if these are properly installed, they will protect the potable water supply. The device shall be installed 6" above the highest sprinkler head and shall have no control valves located downstream from the device.

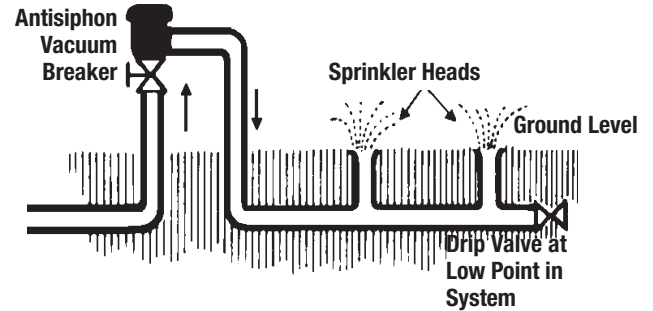

Single Zone System

14 Can an Atmospheric Vacuum Breaker be used under continuous pressure?

No! Codes do not permit this as the device could become “frozen” and not function under an emergency condition.

15 Can a Pressure Vacuum Breaker be used on a multizone lawn sprinkler system?

Yes. This type of vacuum breaker can be used under continuous pressure. Therefore, if properly installed, it will protect the potable water supply. The device shall be installed 12" above the highest sprinkler head.

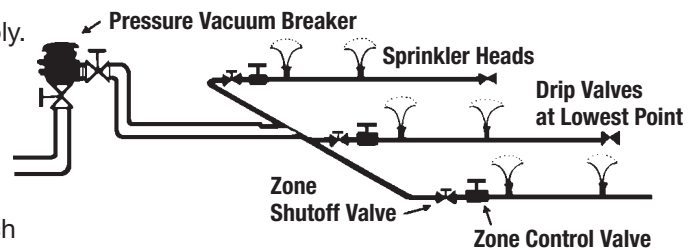

Multizone System

16 What is continuous pressure?

This is a term applied to an installation in which the pressure is being supplied continuously to a backflow preventer for periods of over 12 hours at a time. Laboratory faucet equipment, for example, is entirely suitable for a non-pressure, atmospheric antisiphon vacuum breaker because the supply is periodically being turned on and shut off. A vacuum breaker should never be subjected to continuous pressure unless it is of the continuous pressure type and clearly identified for this service.

17 Are check valves approved for use on boiler feed lines?

Most jurisdictions require backflow protection on all boiler feed lines. Some will allow a backflow preventer with intermediate vent as minimum protection for residential boilers. A reduced pressure backflow preventer is generally required on commercial and compound boilers. However, low cost, continuous pressure backflow preventers are now available which will perform with maximum protection; thus check valves are not recommended.

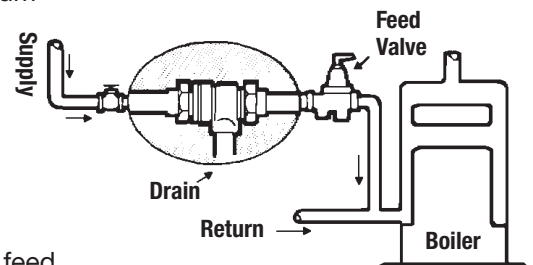

18 What is the difference between pollution and contamination?

Pollution of the water supply does not constitute an actual health hazard, although the quality of the water is impaired with respect to taste, odor or utility. Contamination of the water supply, however, does constitute an actual health hazard; the consumer being subjected to potentially lethal water borne disease or illness.

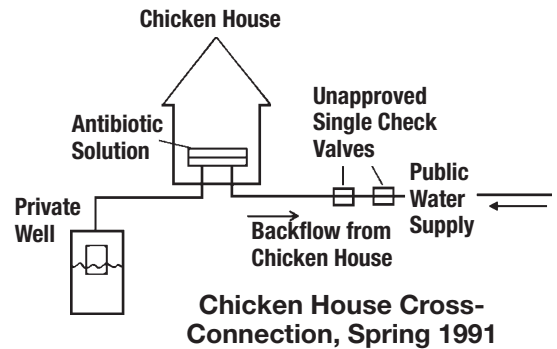

19 What recent case would reflect users being exposed to contamination of the water supply?

Chicken House Cross-Connection, Spring 1991. In response to a complaint from a customer on the Casa Water System (Perry County), a staff member of the Division of Engineering found that the water systems had been contaminated by backflow from chicken houses. The water system connected to the chicken houses included two single check valves in series for backflow prevention purposes. The water was being used to administer an antibiotic solution to the chickens.

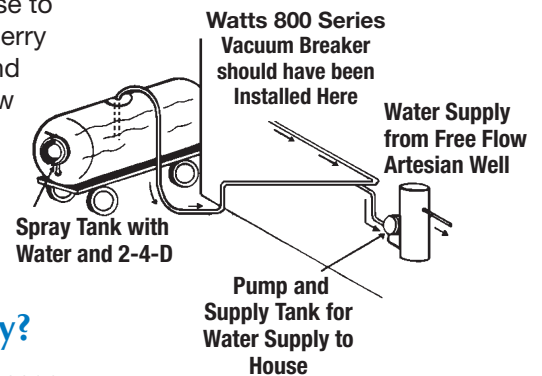

20 What other case reflects users being exposed to "contamination" of the water supply?

On or about the week of the 14th of May, 1991, a backsiphonage problem occurred. A local farmer reported the problem on his farm. He was filling a spray tank on his farm with water and 2-4-D. The wind kept blowing the fill hose away from the fill spout so he extended the hose down into the tank. As the tank filled, he went onto other duties. He went into the house for some reason and his wife told him that the water had become salty tasting. He immediately thought of the 2-4-D and went to the tank, and it had began siphoning water from the tank. He told his wife not to use any more water. An artesian well, (free flow) was filling the tank. The artesian well also supplied water to the home through a storage tank and pump system. As the spray tank was filling, the pump in the house came on and created a pull on the well greater than the pressure at the well head. Consequently, as the pump was on, it was also pulling the 2-4-D and water from the spray tank.

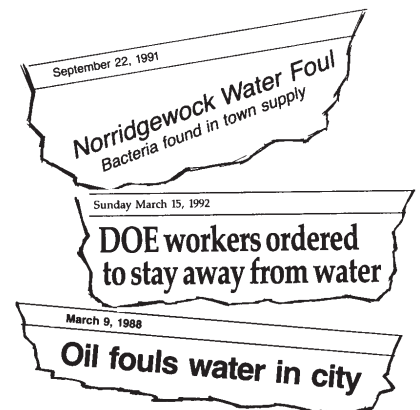

21 Are there any records of recent cases involving unprotected cross-connections?

The startling fact is that cross-connections continue to occur and there are documented cases involving reverse flow. For other cases, request folder F-SBN.

22 What recently reported cases occurred in a plant?

In addition to the case described in "No. 19", there are other reports, but because of the possibility of litigation for pending cases, information can be difficult to obtain. However, in San Francisco, an industrial plant had a submerged water inlet supplying a lye vat. Immediately adjacent to this installation was the employee's shower room. Officials fortunately discovered the cross-connection but were alarmed that employees could potentially be bathing in water contaminated with lye from the vats.

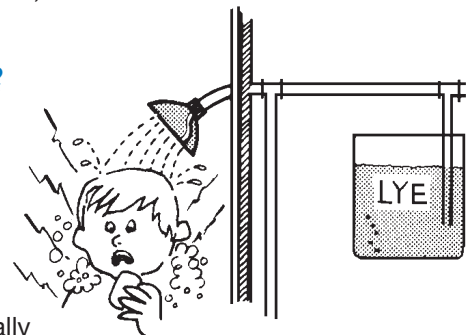

23 What case was reported involving a school?

Most people are familiar with the details of the Holy Cross football team's "hepatitis" incident, which was later determined to be caused by a backflow of contaminated water. It took close to nine months for officials to determine that a severe fire in nearby Worcester lowered the pressure in the football field area to the point where a backpressure backflow condition was created allowing contaminants from a sunken hose bibb pit to backflow into the field house drinking bubbler.

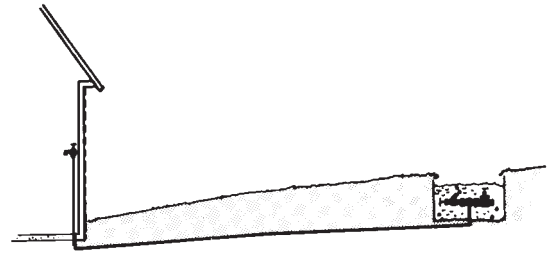

24 What case was reported involving a commercial building?

Much to their surprise, customers of a bank in Atlanta, Georgia saw yellow water flowing from drinking fountains and green ice rolling out of cafeteria dispensing machines.

It was later reported that a pump, used for the air conditioning system, burned out and a maintenance man, unaware of the danger, connected the system to another pump used for potable water. The result caused large doses of bichromate of soda to be forced into the potable water supply, causing the dramatic appearance of yellow water and colored ice cubes.



25 Are there any cases involving outside processing activities?

Yes, a case occurred in a gravel pit operation in Illinois. A pump was used in the processing operation supplying 100 lbs. pressure. Contaminated water was forced back through an unprotected "prime line" overcoming the city water pressure of 45 lbs. The contaminated water entered the city main and was channeled into a nearby bottling plant. This probably would have gone undetected except that personnel in the bottling plant noticed that the water was not only dirty but also was warm. City officials were immediately called which led to the discovery of the reverse flow from the gravel pit operation.

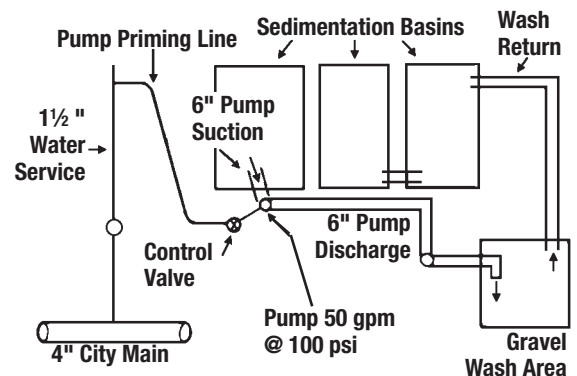

26 What other typical cases have been reported?

Unwanted Guests (Residents find parasites in tap water) Oct. 1991. Parasitological worms were found in the water at two homes after a malfunctioning lawn sprinkler coupled with a water main break sucked the nematodes into the water system.

The nematodes first showed up in the evening of Oct. 1 after the backflow prevention system on the privately owned underground sprinkler malfunctioned. When the water pressure dropped, the vacuum in the system sucked some water from the sprinkler into the city water.

A homeowner found the worms swimming around in his bathtub when he started filling the tub for his child. He said he was appalled to find the critters, as well as rust and other debris in his water. "The only reason I noticed it is because I have children and was giving my kid a bath. If you have a screen on your faucet or you were taking a shower, you wouldn't see it."

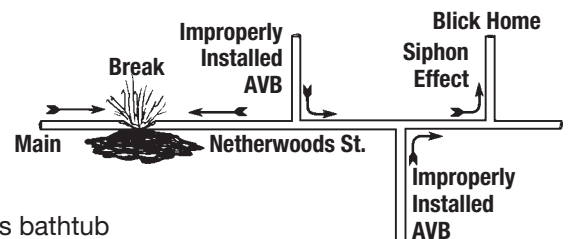

The contractor who installed the sprinkler system didn't pull a city permit and used a "cheap" atmospheric vacuum breaker. When it malfunctioned, which was at the time of the water main break, the nematodes were pulled right in.

In Utah, a doctor reported two gold fish flowing into his bath tub. Earlier in the day he had been filling his gold fish pool with a garden hose when a backsiphonage condition developed resulting in the late emergence of the gold fish into the bath tub.

What is significant, however, is the number of recent cases that are not reported. The number of unprotected cross-connections in existence are potential disasters which can occur any time unless adequate protective devices are installed.

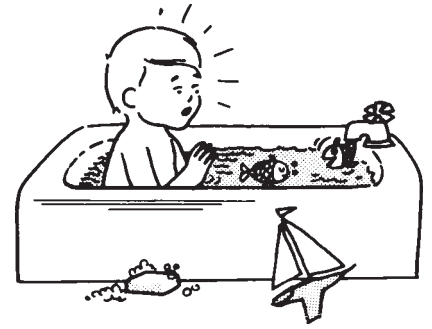

27 What is meant by "Degree of Hazard"?

The "Degree of Hazard" is a commonly used phrase utilized in cross-connection programs and is simply a determination on whether the substance in the non-potable system is toxic (health hazard) or nontoxic (non-health hazard).



Health Hazard



Non-Health Hazard

28 What is the difference between a toxic and a nontoxic substance?

Toxic substance is any liquid, solid or gas, which when introduced into the water supply creates, or may create a danger to health and well-being of the consumer. An example is treated boiler water. A nontoxic substance is any substance that may create a non-health hazard, is a nuisance or is aesthetically objectionable. For example, food stuff, such as sugar, soda pop, etc. Therefore, you must select the proper device according to the type of connection and degree of hazard. There are five basic products that can be used to correct cross-connection.



29 What are the five basic products used for protection of cross-connections?

The five basic products are:

1. Air Gap
2. Atmospheric Vacuum Breakers - which also includes hose connection vacuum breakers
3. Pressure Vacuum Breakers - which also includes backflow preventers with intermediate atmospheric vent for 1/2" and 3/4" lines
4. Double Check Valve Assembly
5. Reduced Pressure Zone Assembly

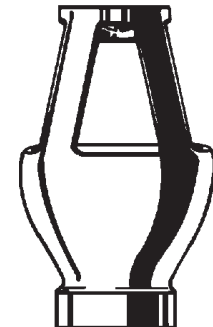

Watts 909AG

30 What is an Air Gap?

Air Gap is the physical separation of the potable and non-potable system by an air space. The vertical distance between the supply pipe and the flood level rim should be two times the diameter of the supply pipe, but never less than 1". The air gap can be used on a direct or inlet connection and for all toxic substances.

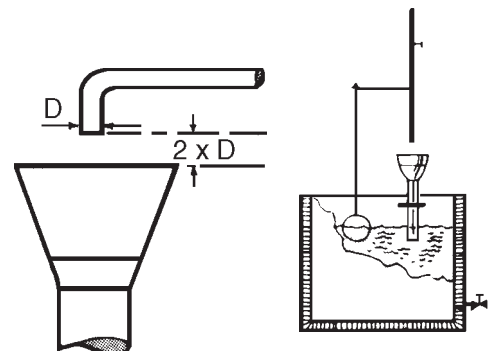

31 Where is an Atmospheric Vacuum Breaker used?

Atmospheric Vacuum Breakers may be used only on connections to a nonpotable system where the vacuum breaker is never subjected to backpressure and is installed on the discharge side of the last control valve. It must be installed above the usage point. It cannot be used under continuous pressure. (Also see No. 11)

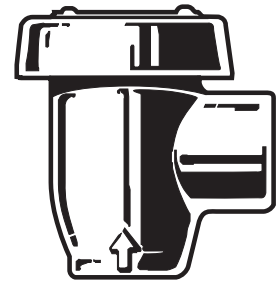

Watts 288A

32 Where is a Hose Bibb Vacuum Breaker used?

Hose Bibb Vacuum Breakers are small inexpensive devices with hose connections which are simply attached to sill cocks and threaded faucets or wherever there is a possibility of a hose being attached which could be introduced to a contaminant. However, like the Atmospheric Vacuum Breaker they should not be used under continuous pressure.

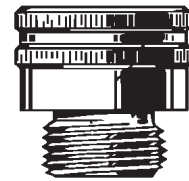

Watts 8

33 Where is a Pressure Vacuum Breaker used?

Pressure Vacuum Breakers may be used as protection for connections to all types of nonpotable systems where the vacuum breakers are not subject to backpressure. These units may be used under continuous supply pressure. They must be installed above the usage point. Spill resistant models for indoor use are also available.

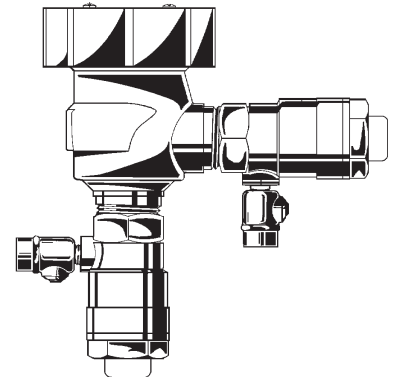

Watts 800M4QT

34 Where is a Backflow Preventer with Intermediate Atmospheric vent used?

These devices are made for 1/2" and 3/4" lines and may be used on non-health hazard cross-connections. They are suitable for use under continuous supply pressure and possible protection against backsiphonage or backpressure backflow

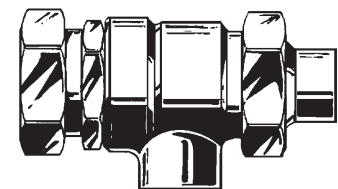

Watts 9D

35 Where is a Double Check Valve Assembly used?

A double check valve assembly may be used as protection for all direct connections through which foreign material might enter the potable system in concentration which would constitute a nuisance or be aesthetically objectionable, such as air, steam, food, or other material which does not constitute a health hazard.

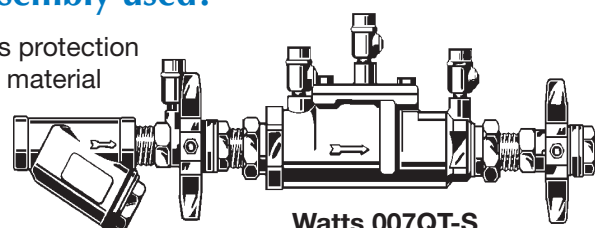

Watts 007QT-S

36 Where is a Reduced Pressure Zone Assembly used?

Reduced Pressure Zone Assemblies may be used on all direct connections which may be subject to backpressure or backsiphonage, and where there is the possibility of contamination by the material that does constitute a potential health hazard.

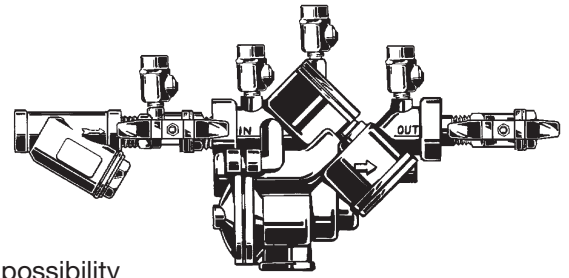

Watts 909QT-S

37 What are typical applications for an Air Gap?

Because today's complex plumbing systems normally require continuous pressure, air gap applications are actually in the minority. It should be remembered, however, that whenever a piping terminates a suitable distance above a contaminant, this itself is actually an air gap. Air Gaps are frequently used on industrial processing applications, but care should be taken that subsequent alterations are not made to the piping which would result in a direct connection.

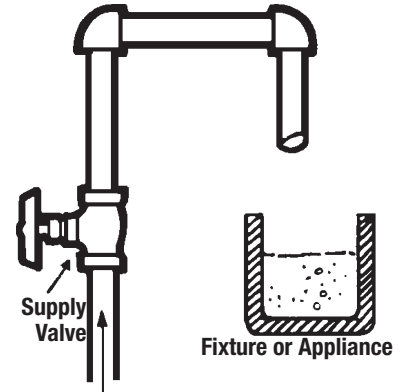

38 What are typical applications for Atmospheric Vacuum Breakers?

Atmospheric Vacuum Breakers can be used on most inlet type water connections which are not subject to backpressure such as low inlet feeds to receptacles containing toxic and nontoxic substances, valve outlet or fixture with hose attachments, lawn sprinkler systems and commercial dishwashers.

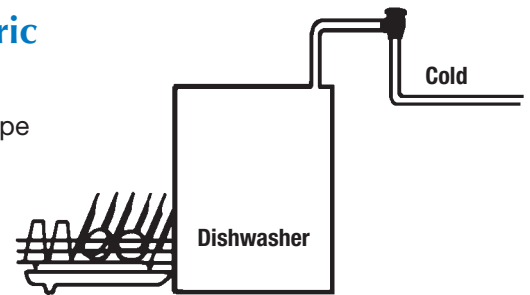

39 What are typical applications for Hose Bibb Vacuum Breakers?

Hose Bibb Vacuum Breakers are popularly used on sill cocks, service sinks and any threaded pipe to which a hose may potentially be attached.

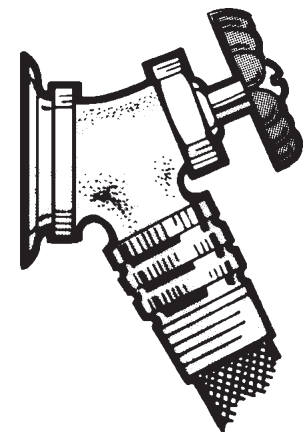

40 What are typical applications for Pressure Vacuum Breakers?

These applications should be similar to the Atmospheric Vacuum Breaker with the exception that these may be used under continuous pressure. However, they should not be subject to backpressure.

41 What are typical applications of Backflow Preventer with Intermediate Vent?

For 1/2" and 3/4" lines these devices are popularly used on boiler feed water supply lines, cattle drinking fountains, trailer park water supply connections and other similar low-flow applications. They will protect against both backsiphonage and backpressure and can be used under continuous pressure.

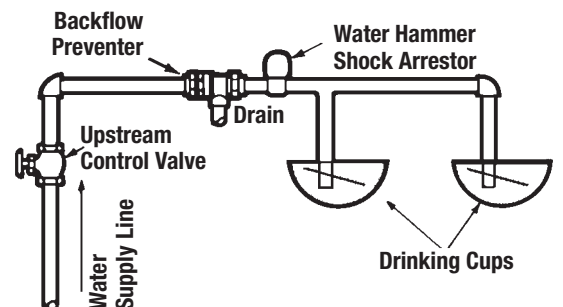

42

What are typical applications for Double Check Valve Assemblies?

Briefly, Double Check Valve Assemblies may be used where the degree of hazard is low, meaning that the non-potable source is polluted rather than contaminated. The degree of hazard is oftentimes determined by local Inspection departments and, therefore, such departments should be questioned in order to comply with local regulations.

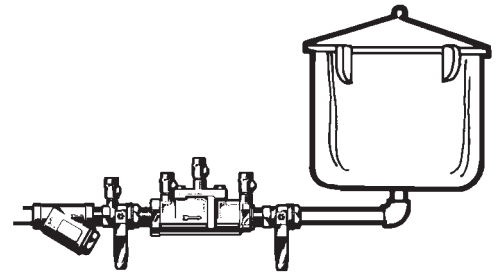

43

What are typical applications for Reduced Pressure Zone Assemblies?

This type should be used whenever the nonpotable source is more of a contaminant than a pollutant. Basically, they are applied as main line protection to protect the municipal water supply, but should also be used on branch line applications where nonpotable fluid would constitute a health hazard, such as boiler feed lines, commercial garbage disposal systems, industrial boilers, etc.

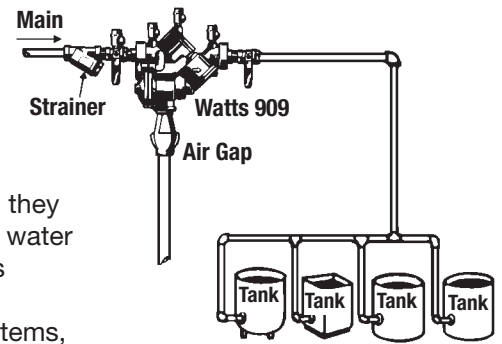

Branch Line Applications

44

Are there any regulations in OSHA regarding cross-connections?

Yes, OSHA requires that no cross-connection be allowed in an installation unless it is properly protected with an approved backflow preventer. These requirements are also covered in B.O.C.A., Southern Std. Building Code, Uniform Plumbing Code and City, State and Federal Regulations.

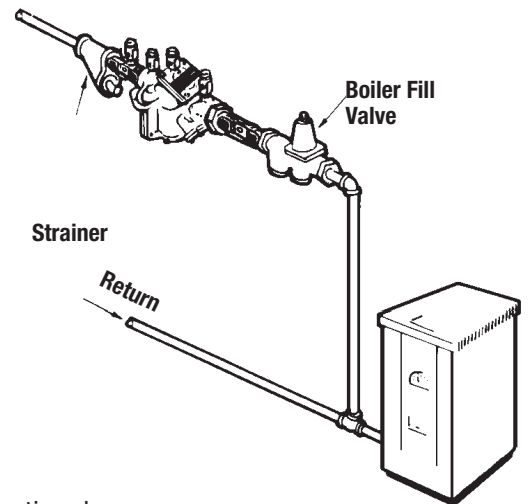

Boiler Feed Lines

45

What Standards are available governing the manufacture of backflow prevention devices?

Standards such as ASSE (American Society of Sanitary Engineering), CSA (Canadian Standards Association), AWWA (American Water Works Association), IAPMO (International Association of Plumbing Mechanical Officials), apply to most backflow prevention products.

46

What is the benefit of a strainer preceding a backflow preventer?

A strainer will protect the check valves of a backflow preventer from fouling due to foreign matter and debris which may be flowing through the line. This not only protects the valve but eliminates nuisance fouling and subsequent maintenance and shutdown. The use of a strainer with a water pressure reducing valve has been an accepted practice for years. The amount of pressure drop attributed to the strainer is negligible and is far outweighed by the advantages provided by the strainer.

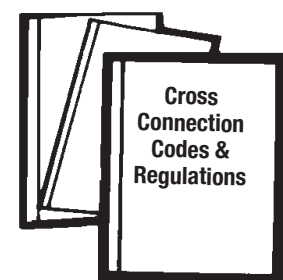

47 What would cause a Reduced Pressure Zone Assembly to leak?

Leakage from a backflow preventer is normally attributed to foreign matter lodging on the seating area of either the first or second check valve. Most times this can be corrected by simply flushing the valve which will dislodge any loose particles. It is, therefore, most important on new installations that the piping be thoroughly flushed before installing the unit. It should be remembered, however, that spillage does provide a “warning signal” that the valve is in need of maintenance.

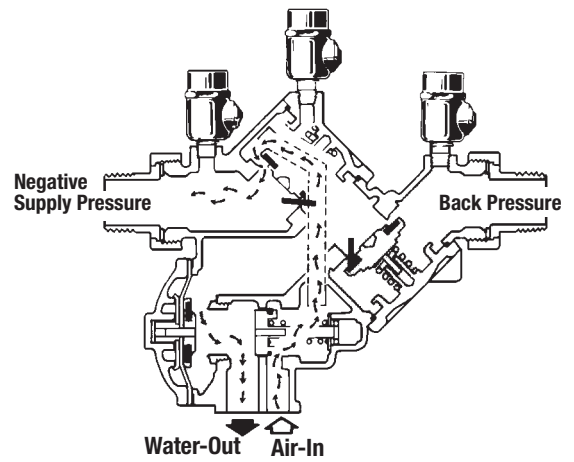

48 Is periodic testing required for Reduced Pressure Zone Assemblies?

Yes, and this is to ensure that the valve is working properly and is a requirement of many states and cross-connection control programs. Test cocks are provided on the valve for this purpose and manufacturers are required to furnish fieldtesting information.

49 Should a backflow preventer be installed in the water supply line to each residence?

Because of the growing number of serious residential backflow cases, many water purveyors are now requiring the installation of approved dual check valve backflow preventers at residential water meters. They are also educating the public concerning cross-connections and the danger of backflow into the local water supply. Since water purveyors cannot possibly be responsible for or monitor the use of water within a residence, the requirements for these cross-connection control programs are increasing throughout the country.

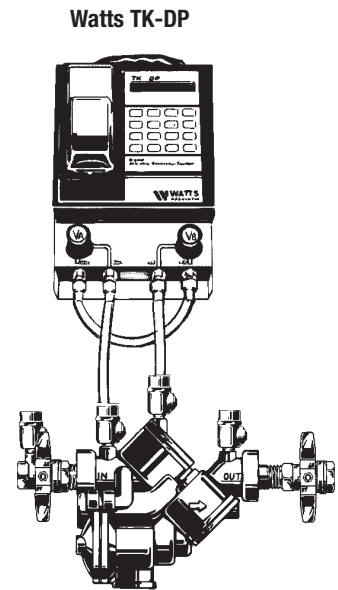

50 What is a cross-connection control program?

This is a combined cooperative effort between plumbing and health officials, waterworks companies, property owners and certified testers to establish and administer guidelines for controlling cross-connections and implementing means to ensure their enforcement so that the public potable water supply will be protected both in the city main and within buildings. The elements of a program define the type of protection required and responsibility for the administration and enforcement. Other elements ensure continuing education programs.





A Watts Water Technologies Company



USA: No. Andover, MA • Tel: (978) 688-1811 • Fax: (978) 794-1848 • www.watts.com
Canada: Burlington, ON • Tel: (905) 332-4090 • Fax: (905) 332-7068 • www.wattscanada.ca